



P Series PiezoJet Printer



Coding for Industry 4.0

[Increased productivity]

Less manual intervention to meet high-efficiency production

[Reliability]

Stable constant temperature ink supply system

[Flexibility]

Compatible with multiple printheads for large-format printing

P7 Pro : 71mm

CAUTION!

PACKAGE HANDLING SYMBOLS



P5 Pro: 54mm

Nutrition Facts



	410 kJ / 98 KCal	Protein 0g
Calories	% Daily Value*	Vitamin A 0%
Total Fat	0%	Vitamin B 0%
Saturated Fat	0%	Vitamin C 0%
Trans Fat	0%	Vitamin D 0%
Cholesterol 0 mg	0%	Calcium 0g
Sodium 0mg	0%	
Total Carbohydrate 0mg	0%	
Sugars	0%	

P3 Pro : 36mm

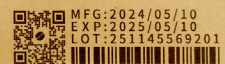

Coding Tomorrow

www.leadtech.ltd

LEAD TECH (ZHUHAI) ELECTRONIC CO., LTD.



Specifications

Model	P3 Pro	P5 Pro	P7 Pro
Printhead	Konica KM512	RICOH MH5420	SEIKO 510
Operating System	LT-Touch Android Operation System		
Max. Line Speed	Max. 55m/min	Max. 260m/min	Max. 55m/min
Print Distance (Recommended)	3-5mm		
Print Resolution	Vertical:360 DPI Horizontal:180 DPI	Vertical:150/300/600 DPI Horizontal:150/300/600 DPI	Vertical:180 DPI Horizontal:180/360 DPI
Ink System	Negative Pressure Ink Supply		
Print Height	36mm	54mm	71.8mm
Communication	Ethernet, USB, RS232, Photocell, Encoder, Alarm Lamp		
User Interface	10.2 inch Industrial Touch Screen		
Power	Input: 100-120/200-240V~ Output: 50/60Hz 0.9/0.45A 99W		
System Language	English, Chinese, Italian, Spanish, Russian and other languages can be upgraded		
Print Message	Text, Variable Text, Date, Time, Shift, Counter, Database Text, Barcode, Graphics, Tables and QR Codes		
Support Database Type	TXT, Excel, Access, SQL Server		
Installation	Sideward and Downward Printing with Standard Bracket, Optional Precise Adjustable Bracket		
Ink Type	Oil based and UV ink		
Ink Management	Auto-identify Ink Type and Confirm Optimal Parameter, Auto-calculate Ink Consumption		
Operating Environment	59°F(15°C)-104°F(40°C)		
Storage Environment	41°F(5°C)-113°F(45°C)		
Printhead Specification	392.75mmx143mmx56mm	392.75mmx169mmx56mm	322.75mmx169mmx56mm

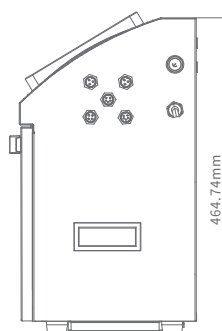
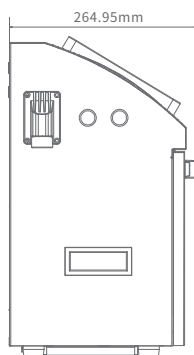
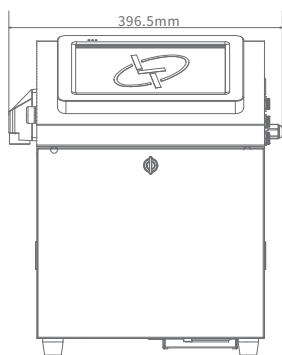
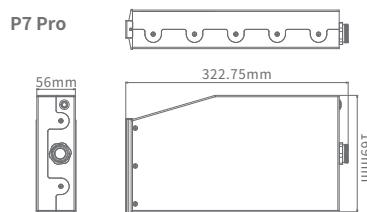
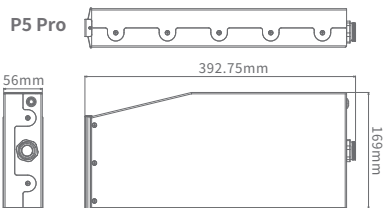
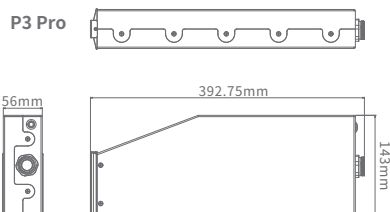
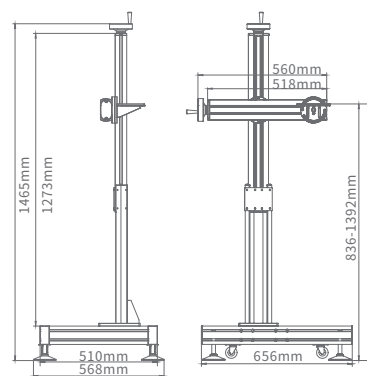

LEAD TECH (ZHUHAI) ELECTRONIC CO., LTD.

Tel: +86 756-7255629

Fax: +86 756-7255638

Web: www.leadtech.ltd

Add: Floor 3/4, Building 1, No. 728, Jinhu Road, Sanzao Town, Jinwan District, Zhuhai City